

**SISTEMA
DI ARREDO
FURNISHING
SYSTEM**





extraordinary ideas



Ci sono **idee** che ti cambiano la **vita**. A volte basta davvero poco: un colore, una **forma**, una linea e gli **spazi** che ti circondano si aprono, cambiano aspetto, riescono ad **emozionarti**. È quello che succede con Exe. Il sistema estendibile di arredo universale che dà agli ambienti un carattere unico. Come il tuo. Così inventare il tuo mondo diventa davvero speciale. Exe, **idea straordinaria**.

There are **ideas** that will change your **life**. Sometimes it just takes very little: a colour, a **shape**, a line and **spaces** unfold around you, change their appearance, succeed in **exciting you**. That's what happens with Exe. The extensible system of universal furniture gives a unique character to rooms. As your own one. Thus it becomes really special to think up your world. Exe, the **extraordinary idea**.



STYLE

L'interior design si arricchisce di **stile** e praticità.
The interior design is enriched with **style** and functionality.



04/05
more than an extension



dimension

L'immaginazione si apre ad una nuova **dimensione**. La dimensione Exe.
The imagination opens up to a new **dimension**. The Exe dimension.

06/07
more than an extension

Fatto per essere ammirato, progettato per la massima **funzionalità**,
Exe è perfetto se vuoi creare un ambiente ricercato e d'impatto.
Made to be admired, designed for the maximum **functionality**,
Exe is perfect for those who want to create a sophisticated and
impacting environment.

08/09
more than an extension





10/11
more than an extension



im
a
g
i
n
e



Crea tutto quello che puoi **immaginare**. Arreda gli ambienti
in modo nuovo, multilivello, multicolore, multifunzione.
Get everything you can **imagine**. Furnish your rooms in a
new, multilevel, multicoloured, multifunctional way.

12/13
more than an extension



Forme che arredano il **living**:
i materiali si fondono,
lo spazio ha una nuova profondità.
Shapes to decorate the **living** area:
materials are melted,
the space has a new depth.

14/15
more than an extension

TECHNICAL DATA

BOISERIE

ALTEZZA BOISERIE_BOISERIE HEIGHT

A soffitto_To the Ceiling: h. max cm. 300

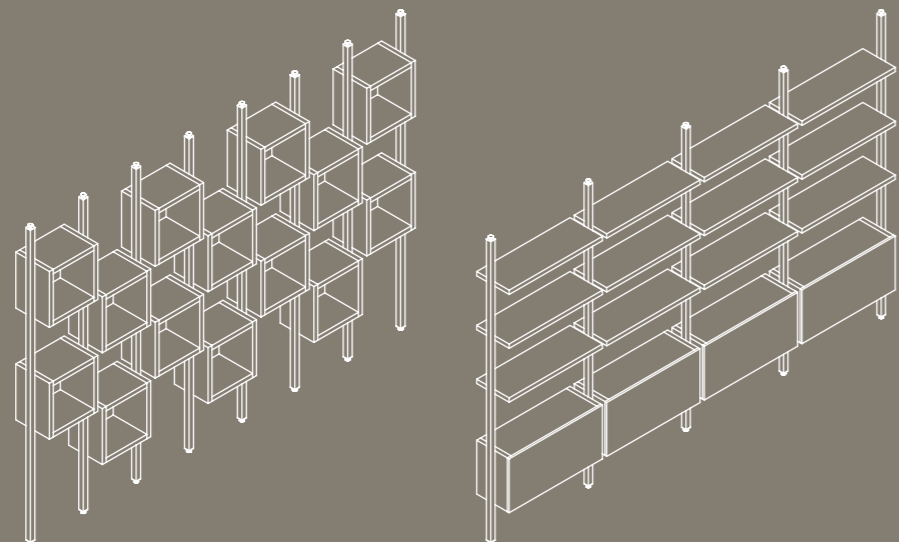

DIMENSIONI CONTENITORI BOISERIE BOISERIE UNIT DIMENSIONS

cm. 95x33x47,5

cm. 47,5x33x47,5

DIMENSIONI MENSOLE PER BOISERIE BOISERIE SHELVES DIMENSIONS

cm. 95x33

cm. 47,5x33

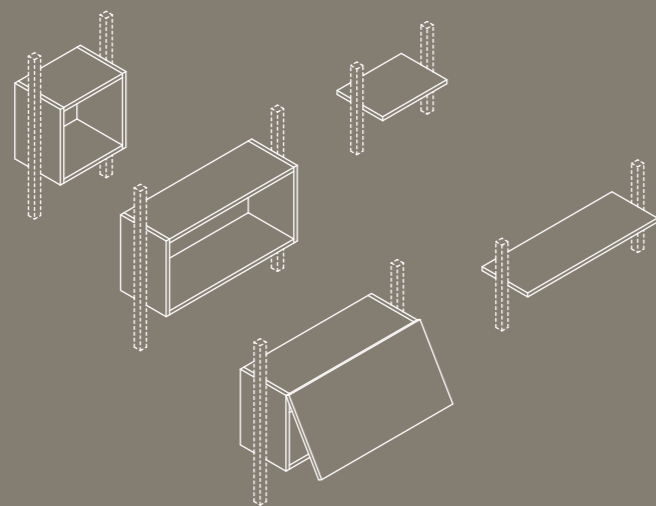

16/17

more than an extension



FINITURE_FINISHINGS

MENSOLE, CONTENITORI PER BOISERIE SHELVES, BOISERIE UNITS

LACCATI LACQUERED

Laccato nero_Black lacquered

Laccato bianco_White lacquered

Laccato fango_Mud lacquered

Laccato lilla_Lilac lacquered

LEGN WOODS

Wenge_Wenge

Noce Canaletto_“Canaletto” walnut

Rovere sbiancato_Bleached oak

Acero_Maple

Alluminio_Aluminium

Bianco Luce_Light white

VETRI GLASSES

Laccato nero_Black lacquered

Laccato bianco_White lacquered

Acidato_Etched

Trasparente_Transparent

STRUTTURE BOISERIE BOISERIE STRUCTURES

Alluminio anodizzato
Anodized Aluminium

Alluminio brillantato
Polished Aluminium

Bianco_White



TECHNOLOGY

L'ufficio di oggi? Attento al comfort, gioca con i volumi e la mobilità. Con la **tecnologia** Exe puoi personalizzare il tuo ambiente e creare un concept unico.

Today's office? Careful with the comfort, playing with volumes and mobility. You can customize your room with Exe **technology** and create a unique concept.

EXE



20/21
more than an extension

Sovrapponibili ed estensibili a piacere,
queste composizioni possono essere
ampliate con il mutare delle esigenze e
personalizzate di volta in volta.

Per crescere con il tuo **business**.

Stackable and extensible as desired,
these compositions can be expanded
with the changing of requirements and
customized at all times.

To grow up with your **business**.





24/25
more than an extension





Modulare e resistente, combina tutte le possibilità Exe con la tua **idea** di architettura.
Modular and strong, combine all Exe possibilities with your own **idea** of architecture.



Progetta: ogni esigenza ha una sua **soluzione** Exe.
Design: each requirement has an Exe **solution**.

30/31
more than an extension





Unisci gli elementi verticali a scrivanie,
posti lavoro e pareti e crea grandi
prospettive, mixando le diverse
finiture: legno, laccato e vetro.
Combine vertical elements with desks,
workstations and partitions to create
great **perspectives**, mixing different
finishings: wood, lacquer and glass.

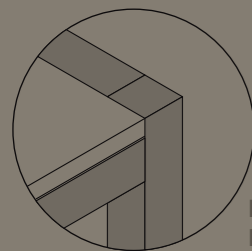

PIANO AFFOGATO
DROWNED DESK TOP

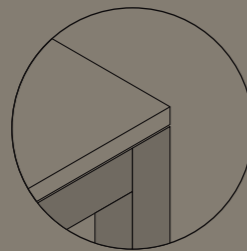

PIANO SOVRAPPPOSTO
SUPERIMPOSED DESK TOP

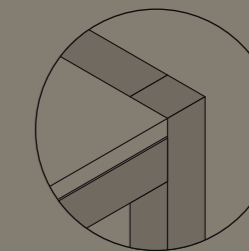

PIANO AFFOGATO
DROWNED DESK TOP

TECHNICAL DATA

TECHNICAL DATA

SCRIVANIE SINGOLE_SINGLE DESKS

PROFONDITÀ_DEPTH cm. 80

cm. 80x80

cm. 120x80

cm. 140x80

cm. 160x80

cm. 180x80

cm. 200x100

PROFONDITÀ_DEPTH cm. 60

cm. 80x60

cm. 120x60

cm. 140x60

cm. 160x60

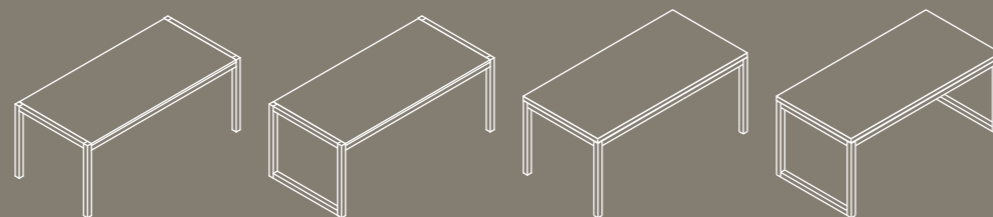

SCRIVANIE CONTRAPPOSTE_OPPOSITE DESKS

PROFONDITÀ_DEPTH cm. 164

cm. 80x164

cm. 120x164

cm. 140x164

cm. 160x164

cm. 180x164

PROFONDITÀ_DEPTH cm. 124

cm. 80x124

cm. 120x124

cm. 140x124

cm. 160x124

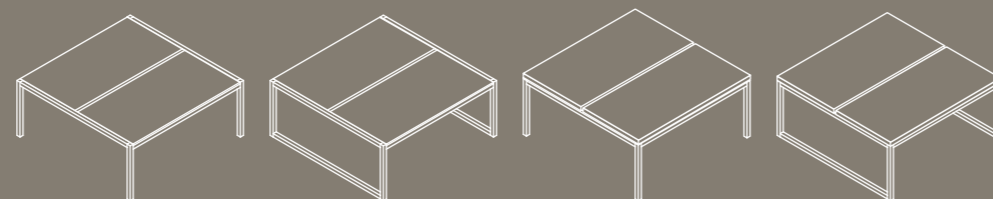

ALLUNGHI_RETURNS

cm. 80x60

cm. 120x60

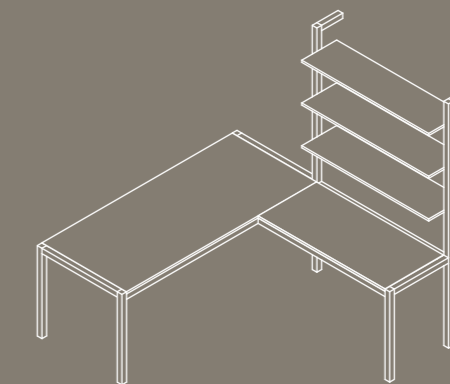
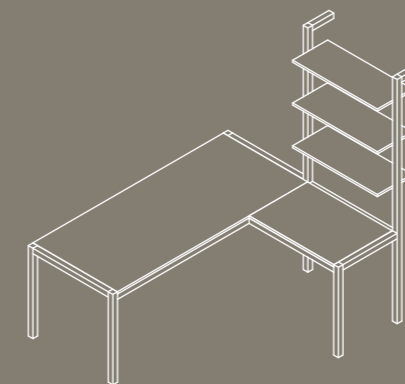
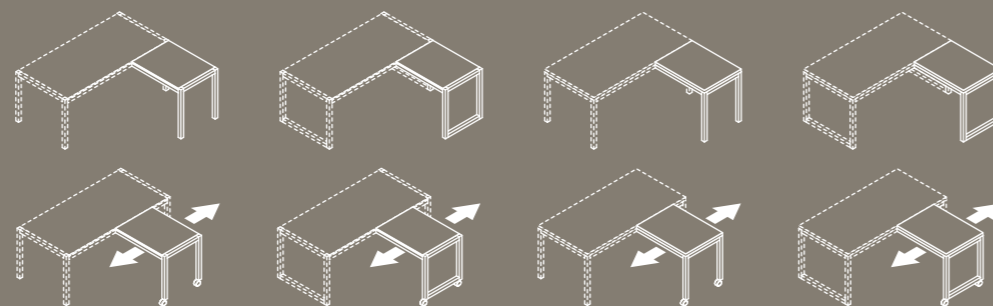

SCRIVANIE CON BOISERIE DESKS WITH BOISERIE

cm. 120x180x300

cm. 140x180x300

cm. 160x180x300

cm. 120x200x300

cm. 140x200x300

cm. 160x200x300

COMPOSIZIONI HOME-STUDIO HOME-STUDIO COMPOSITIONS

cm. 80x60x200

cm. 160x60x200

cm. 120x80x300

cm. 160x80x300

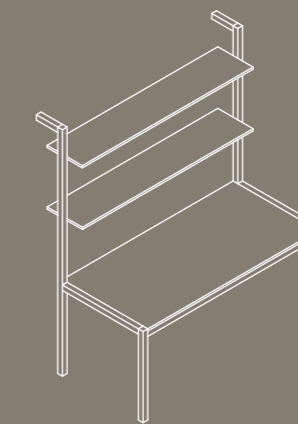
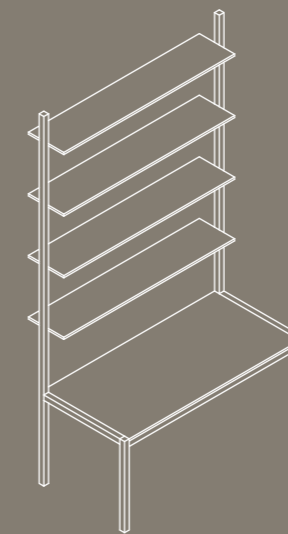

- 1 GAMBA QUADRA_SQUARE LEG
- 2 GAMBA A PONTE_BRIDGE LEG
- 3 PIEDINO CON LIVELLATORE_ADJUSTABLE FOOT
- 4 GAMBA REGOLABILE IN ALTEZZA_ADJUSTABLE LEG
- 5 GAMBA CON RUOTA_WHEEL LEG
- 6 PIANO SCRIVANIA VETRO SOVRAPPOSTO
SUPERIMPOSED GLASS DESK TOP
- 7 PIANO SCRIVANIA VETRO AFFOGATO_DROWNED GLASS DESK TOP
- 8 PIANO SCRIVANIA LEGNO SOVRAPPOSTO MM. 18
SUPERIMPOSED WOOD DESKTOP MM. 18 THICK
- 9 PIANO SCRIVANIA LEGNO AFFOGATO MM. 18
DROWNED WOOD DESK TOP MM. 18 THICK
- 10 PIANO SCRIVANIA LEGNO SOVRAPPOSTO MM. 30
SUPERIMPOSED WOOD DESK TOP MM. 30 THICK
- 11 PIANO SCRIVANIA LEGNO AFFOGATO MM. 30
DROWNED WOOD DESK TOP MM. 30 THICK

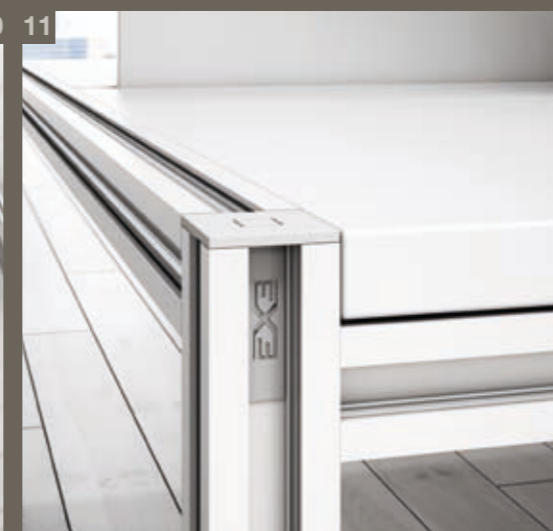

FINITURE_FINISHINGS PIANI SCRIVANIA, ALLUNGHI_DESK, RETURNS

LEGNI WOODS

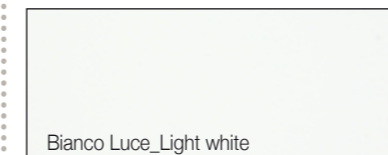
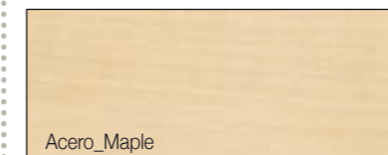
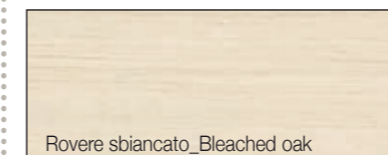
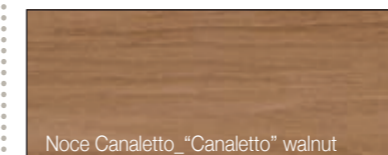
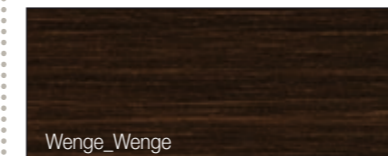

VETRI GLASSES

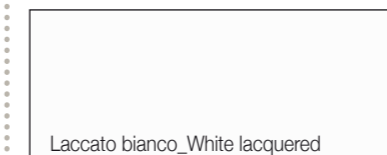
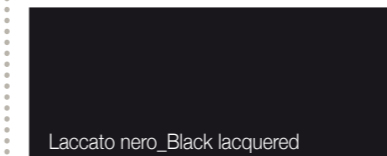

STRUTTURE SCRIVANIE DESK STRUCTURES





DESIGN

|| **design** s'illumina. The **design** grows brighter.

EXE

extensible

L'ampia **componibilità** dei moduli estensibili ti permette di risolvere in modo elegante e funzionale l'arredo nei tuoi ambienti di lavoro, negli interni più ricercati e nei punti vendita. The large modularity of **extensible** modules allows you to settle the furniture in an elegant and functional way, as in your workplaces as in more refined interiors and stores.

40/41
more than an extension





Lampade, libri, cd, orologi, abiti, prodotti per i tuoi clienti.
Crea configurazioni minimali o complesse. Basta scegliere materiale e
colore, con Exe c'è **spazio** per tutto il tuo mondo.
Lamps, magazines and books, CDs, watches, clothes, products for
your customers. Create minimal or complex configurations. Just choose
material and colour and there is **space** for all your world with Exe.

L'anima calda e avvolgente del legno.
Le possibilità **creative** delle finiture
laccate. La trasparenza eterea del vetro.
La bellezza sta nel poter vedere ciò che
si immagina.

The warm and inviting soul of woods.
The **creative** possibilities of lacquered
finishings. The ethereal transparency of
glasses. The beauty stands where you
can see what you imagine.



44/45
more than an extension



**SCEGLIERE
IL MEGLIO
VUOL DIRE
SCEGLIERE
DI TUTELARE
L'AMBIENTE.**

Scegliamo materiali eco-compatibili, resistenti riciclabili nel tempo, come alluminio, vetro e pannelli con certificazione FSC, perché crediamo in un'innovazione attenta all'ambiente.

**CHOOSING THE
BEST MEANS
TO CHOOSE TO
SAFEGUARD
THE
ENVIRONMENT.**

We choose eco-friendly materials, recyclable and durable over time, as aluminium, glass and FSC certified panels, because we believe in an environmentally conscious innovation.



Legno proveniente da foreste gestite con rigorosi standard ambientali, sociali ed economici.
Wood from forests managed with strict environmental, social and economic standards.



Certificazione della gestione forestale sostenibile.
Programme for Endorsement of Forest Certification.



Utilizzo di materiali ecologici.
Use of ecological materials.



Materiali a bassa emissione di formaldeide.
Low formaldehyde emission materials.



Imballi totalmente riciclabili.
Packing totally recyclable.



Prodotti conformi alle direttive CEE.
Products comply with CEE directives.



Certificato di Qualità ISO 9001.
Quality Management System Certified.



Sistema progettazione, produzione, installazione certificato ISO 9001.
Certified system of projecting, production, installation.



Laboratorio autorizzato all'effettuazione di prove secondo le normative italiane ed estere.
Laboratory authorized to perform testing in compliance with Italian and foreign regulations.

UNI-EN

Prodotti conformi alle norme UNI - EN.
Products comply with UNI - EN standards.

assUfficio
Associazione nazionale delle industrie del mobile e dell'arredamento della Federlegno-Arredo



Azienda associata.
Associate company.

Per ordinare consultare il listino prezzi.

I colori dei rivestimenti fotografati possono non corrispondere agli originali.

La ditta si riserva il diritto di apportare modifiche al prodotto senza preavviso.

Catalogo non in vendita, distribuito gratuitamente alla clientela.

To place an order please look at the price list.

Finishings of furniture in the catalogue may not be in conformity with the original ones.

Styloffice SpA keeps the right to modify the product without forewarning.

The catalogue is not for sale but is intended free of charge to clients.



Agency_molokoplus.it

AD_Paola Flamminio

3D Graphic Designer_Filippo Petrucci

Copy_Angela Ciampagna

Print_Artelito

Research and Development_Styloffice

November 2012



Styloffice S.p.A. • Via Val di Foro (Z.Ind.) • 66010 Miglianico (CH) • ITALY
Tel. (+39) 0871.95.05.70 r.a. • Fax (+39) 0871.95.05.71 • info@styloffice.com • www.styloffice.com